

USER MANUAL

Model: TW-2



Outdoor TV Tilting Wall Mount



SÉURA[®]

www.seura.com

Safety

Overall Dimensions (W x H): 33.8" x 8.0" x 1.75" D (3" depth at full tilt)
Tilt: +0.00° / - 10.00°

This product is designed to mount televisions weighing up to 165 lbs to a vertical firm wall.

Safety Warning: Ensure that there are no missing or defective parts upon receipt. Never use defective parts. Improper installation may cause damage or serious injury.











Note: The included hardware is for mounting on walls. If you are uncertain about the nature of your wall, consult an expert. Please consult your hardware or installation professional for proper mounting to other types of walls.



CAUTION

DO NOT EXCEED MAXIMUM LISTED WEIGHT CAPACITY. SERIOUS INJURY OR PROPERTY DAMAGE MAY OCCUR!

Supplied Parts

Ⓐ		x1	Ⓑ		x2	Ⓒ		x6	Ⓓ		x6
Ⓔ		x6	Ⓕ		x4	Ⓖ		x4	Ⓗ		x4
Ⓘ		x4	Ⓙ		x4	Ⓚ		x4	Ⓛ		x12

Note: Séura TVs up to 65" require M6 bolts to mount to the TV. However, several sizes are included for flexibility.

Instructions

1. Attach Wall Plate to Wall

Note: This product should be mounted to concrete, stone, brick, or wood studs.

1a. Solid Surface Wall Mounting (concrete, stone, or brick): Use the wall plate (a) as a template to mark six hole locations on the wall (four in the top row slots and two in the bottom row). Ensure that the hole locations are level and there is at least 8 inches between any two holes. Pre-drill these holes with a 10mm masonry bit to at least 60mm in depth. Insert a concrete anchor (e) into each of these holes. Attach the wall plate to the wall using six lag bolts (c) and six lag bolt washers (d).

1b. Drywall/Stud Wall Mounting: The wall plate (a) must be mounted to at least two wood studs. Use a stud sensor to locate three adjacent studs. Pre-drill a 55mm deep hole using a 4.5mm drill bit. Use the Wall Plate as a template to mark the location of the second hole in each stud. Attach the wall plate to the wall using the four lag bolts (c) and four lag bolt washers (d).

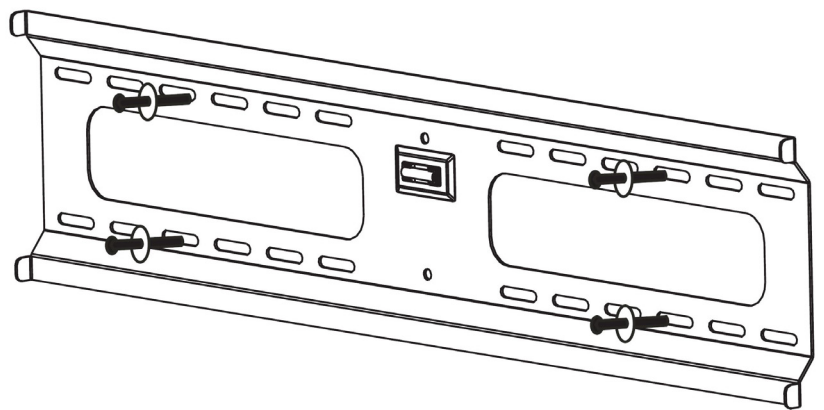

2. Attach TV Rails to TV

Make sure the two TV Rails (b) are mounted at an equal distance from the top of the TV and as close to the center as possible. Séura Outdoor TVs up to 65" require M6 bolts.

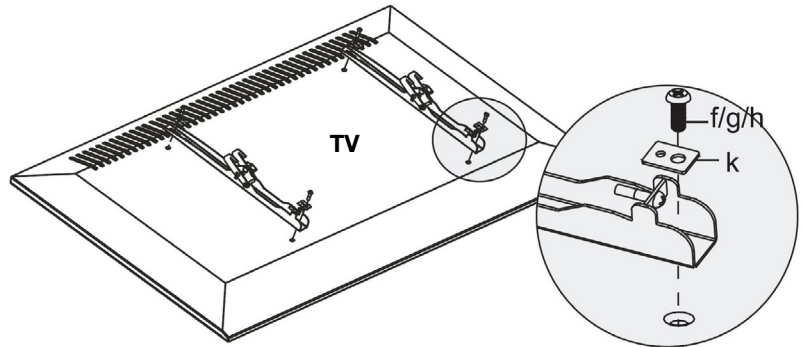

3. Hang TV and Adjust

NOTE: NEVER TRY TO HANG A TV BY YOURSELF. ALWAYS USE AT LEAST TWO PEOPLE TO LIFT THE TV INTO PLACE.

First, hook the TV rails over the top off the wall plate. Then, tighten the safety screws on the bottom of the TV rails. Finally, adjust your TV for optimal viewing. Séura recommends tilting the TV down by 10 degrees to reduce reflectivity. To adjust the tilt, loosen the knobs on the right and left of the TV on the TV rails. Tilt the TV to the desired angle and retighten both knobs.

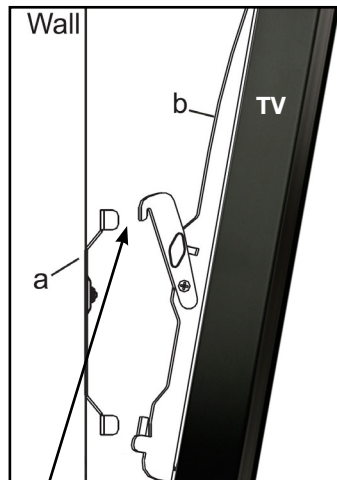

Hook TV Rails to Wall Plate

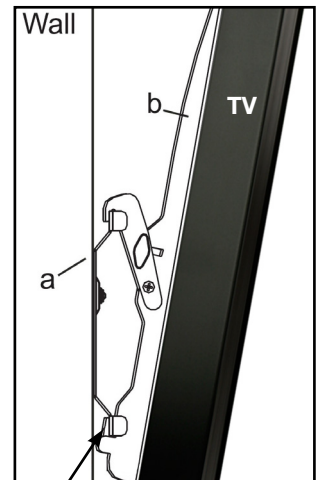

Tighten Safety Screw

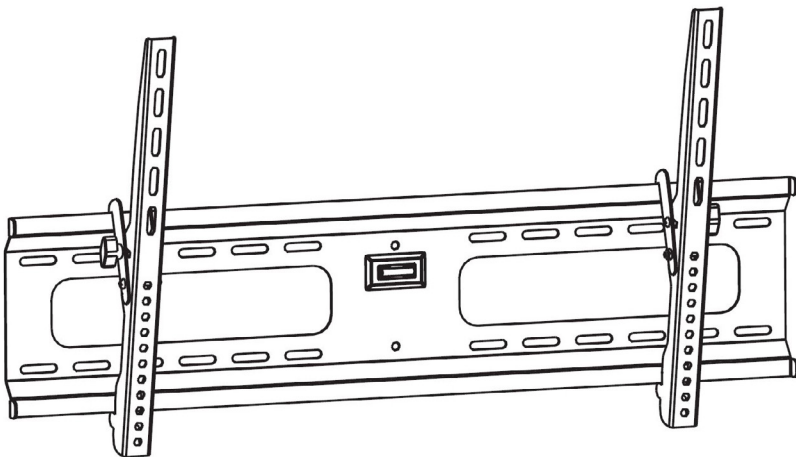

Séura recommends checking knobs, screws, and bolts every 2-6 months. Regular adjustments, wind, and normal wear and tear can loosen hardware over time.

If you have any questions regarding installation, please contact Séura Support at 1-800-957-3872.

PRODUCT LIMITED WARRANTY

If a Séura, Inc. ("Séura") Product (the "Product" or "Products") fails to work or operate properly because of a defect in materials or workmanship, Séura will, for the length of the period indicated below, (starting on the date of the customer's purchase receipt for the Product), at its option, either; (a) repair the Product with new or refurbished parts onsite or at Séura's factory, including Séura's labor if applicable; or (b) replace the Product with a new or refurbished Product; or (c) refund of the lesser of a pro rata share of the current MSRP as determined by the remainder of the warranty period if replacement of the Product is not commercially feasible. The remedy chosen will be in good faith and at the discretion of SÉURA.

Séura warrants **Lighted Mirrors** with respect to Séura's Labor for three (3) years; Mirror, Glass, Structure, Frame, and Assembly for three (3) years; Electrical for five (5) years; LED light strips for five (5) years. Fluorescent Lamps are not warranted.

Séura warrants **TV Mirrors** with respect to Séura's Labor for three (3) years; Mirror, Glass, Structure, Frame, and Assembly for three (3) years; TV including remote and power supply for two (2) years.

Séura warrants **Lighted TV Mirrors** with respect to Séura's Labor for three (3) years; Mirror, Glass, Structure, Frame, and Assembly for three (3) years; electrical excluding TV for five (5) years; LED light strips for five (5) years. TV including remote and power supply for two (2) years. Fluorescent Lamps are not warranted.

Séura warrants **Indoor Waterproof TVs** with respect to Séura's Labor for three (3) years; Glass, Structure, Frame, and Assembly for three (3) years; TV including remote and power supply for two (2) years.

Séura warrants **Outdoor TVs** with respect to Séura's Labor for two (2) years; Glass, Structure, Frame, and Assembly for two (2) years; TV including remote and power supply for two (2) years.

Séura warrants **Indoor and Outdoor TV Mounts** for two (2) years against defects in original hardware and/or workmanship. Excludes corrosion or rust resulting from damaged, scratched or chipped paint or other surfaces.

Séura warrants **Protective TV Covers** for two (2) years against material and/or workmanship defects. Excludes normal wear & tear.

This Limited Warranty extends only to the original purchaser of a Product and only covers a Product purchased new. Séura reserves the right to require any warranty claimant to produce the original purchase receipt or other original purchase date proof as may be reasonably required by Séura to verify the Product's warranty eligibility.

1. **Exceptions to Warranty:** Séura does not warrant the Products against defects arising out of, related to, or caused by, whether totally or partially, and whether directly or indirectly, any of the following:
 - A. Failing to properly clean and maintain, any Product, part or component of a Product, including, but not limited to, filters, front bezel, and other Product areas or components;
 - B. A Product's extended use, including particularly, commercial applications, where a Product is operating on average more than twelve (12) hours per day on a permanent or extended periodic basis;
 - C. Circumstances, damage (including concealed damage) or other conditions occurring during shipment of a Product or at any time after a Product leaves Séura's facility;
 - D. Circumstances, damage or other conditions occurring during unpacking and/or removal of a Product from its original packaging, including the removal of protective material;
 - E. Circumstances, damage or other conditions occurring during transport of the Product to or from Séura before or after authorized service. Products must be packed properly using original packaging or Séura replacement or pre-authorized packaging. Customer assumes all risk, and costs, including transportation costs, while Product is in transit to or from Séura.
 - F. Improper, incorrect, or insufficient AC supply voltage to a Product;
 - G. Alterations, modifications, including use of unauthorized mount, or changes to a Product without Séura's prior written authorization;
 - H. The incorporation of a Product into or within a Product of a third party, without Séura's prior written authorization;
 - I. A Product's misuse, neglect use, abuse, or improper operation, including the failure to follow a Product's normal and ordinary operating instructions;
 - J. The effects of fire, flood, lightning, electrical surges, water and other liquid infiltration, smoke, insect or animal infestation, sand, mud, chemicals, improper cleaning agents and other substances not intended to come into contact with a Product, including any such substances contact with a Product as the result of acts of God;
 - K. The improper or faulty installation, setup, or adjustment of a Product;
 - L. A Product's repair, attempted repair, or total or partial disassembly by any party other than a Séura authorized service representative;
 - M. When the Product occurs with pixel errors within the specified and permitted area. For more information about this, inquire directly with Séura regarding the Séura Pixel Policy.
 - N. Corrosion that does not affect the performance of a Product or the reasonable cosmetic appearance of a Product; and
 - O. Scratches or other paint or finish damage to a Product that lead to or are caused by, in part or in total, corrosion.
 - P. When a Lighted Mirror or Lighted TV Mirror using LEDs retains an overall brightness greater than 70% of the original brightness, including cases whereas an individual LED fails.
 - Q. Lack of proof of original proof of purchase.
 - R. Damage due to exhausted or incorrectly installed batteries.
2. **Warranty Disqualifiers.** This Limited Warranty does not apply, and Séura makes no warranties or representations, with respect to any Product being free from defects in materials or workmanship if the Product was purchased from a seller who is not authorized, by Séura, to sell Séura Products, is owned by or is in possession of an individual or entity who is not the original purchaser of the Product, or if the Product's original Séura serial number has been removed, defaced, replaced, or otherwise tampered with in any manner.
3. **Limitation of Liability.** THE SPECIFIC TERMS OF THIS LIMITED WARRANTY ARE IN LIEU OF ALL OTHER WARRANTIES, ORAL, EXPRESSED OR IMPLIED, INCLUDING, BUT NOT LIMITED TO, ANY IMPLIED WARRANTIES OF FITNESS FOR A PARTICULAR PURPOSE OR USE. SÉURA WILL NOT BE LIABLE FOR ANY DAMAGE TO OTHER PROPERTY CAUSED BY ANY DEFECT IN THE PRODUCT, DAMAGES BASED ON INCONVENIENCE, LOSS OF BUSINESS OPPORTUNITY, LOSS OF GOODWILL, INTERFERENCE WITH BUSINESS RELATIONSHIPS, OR OTHER COMMERCIAL LOSS, EVEN IF THE CUSTOMER HAS BEEN ADVISED OF THE POSSIBILITY OF SUCH DAMAGES. SÉURA WILL NOT BE LIABLE FOR ANY LOSS, DAMAGE OR LIABILITY OR ANY DIRECT, INCIDENTAL, INDIRECT, PUNITIVE, SPECIAL OR CONSEQUENTIAL DAMAGES RESULTING FROM THE USE OR MISUSE OF A PRODUCT, OR ARISING OUT OF ANY BREACH, BY THE PURCHASER OF A PRODUCT, OF THIS LIMITED WARRANTY. SÉURA SHALL NOT BE LIABLE FOR ANY CLAIM AGAINST THE CUSTOMER BY ANY OTHER PARTY. SÉURA SHALL NOT BE LIABLE FOR ANY VERBAL WARRANTY ASSURANCES MADE BY A SÉURA EMPLOYEE OR A SÉURA AUTHORIZED DISTRIBUTOR, RESELLER OR INSTALLER THAT CONFLICTS WITH OR ENHANCES THE WRITTEN WARRANTY HEREIN. SOME STATES DO NOT ALLOW THE EXCLUSION OR LIMITATION OF INCIDENTAL OR CONSEQUENTIAL DAMAGES, OR LIMITATIONS ON HOW LONG AN IMPLIED LIMITED WARRANTY LASTS, SO THE EXCLUSIONS MAY NOT APPLY TO A PARTICULAR PURCHASER. NOTWITHSTANDING ANYTHING CONTAINED IN THIS LIMITED WARRANTY TO THE CONTRARY, SÉURA'S MAXIMUM AGGREGATE LIABILITY TO A PURCHASER RELATED TO ANY WARRANTY CLAIM OR ALLEGATION OF A DEFECT WITH RESPECT TO A PRODUCT SHALL NOT EXCEED THE THEN CURRENT SÉURA WHOLESALE PRICE OF THE SPECIFIC PRODUCT FROM WHICH THE WARRANTY CLAIM DERIVES.
NOTICE OF ANY WARRANTY CLAIM MUST BE RECEIVED BY SÉURA, IN WRITING, PRIOR TO THE EXPIRATION OF THE APPLICABLE WARRANTY PERIOD SET FORTH ABOVE. THE PRODUCT WARRANTY APPLIES ONLY FOR THE PERIODS SET FORTH ABOVE.
4. **Warranty Procedure.** A warranty claimant must contact Séura at **920-857-9069** for a diagnostic. Please have your Product receipt available. At that time, Séura will provide technical support over the phone to attempt to fix the problem. If unsuccessful, a Séura Representative will determine if the Product will be serviced onsite, replaced, or returned to Séura's factory in Green Bay, Wisconsin for repair.
 - Toll-Free Technical Support: Please call 1-800-957-3872 to speak with a Séura Technical Support Representative. Séura Representatives are available Monday-Friday, 8:00am-4:30pm Central Time.
 - Onsite Service: If Technical Support determines the problem may be fixed onsite, a Séura service agent will be scheduled within 24 hours to service the unit. A Séura representative will work with the customer to schedule a convenient time for onsite service. Parts may be sent to the customer's location. Onsite service is available in the United States during normal business hours Monday - Friday, unless other special circumstances exist and special arrangements are made.
 - Factory Service: If Technical Support determines the Product must be sent back to Séura's factory for repair, the customer must follow return instructions below. Séura will ship the repaired Product to the authorized reseller, installer or customer's address. This warranty does not cover removal or installation costs of Products.
 - Advanced Replacement: If Technical Support determines the Product must be replaced, Séura will ship a new Product to the authorized reseller, installer or customer's address. The customer must follow return instructions below to send the damaged Product back to Séura's factory. Credit card information will be collected before shipment of the replacement Product. If Séura does not receive the original Product back within thirty (30) days of shipping the replacement Product, the credit card on file will be charged at full MSRP. This warranty does not cover removal or installation costs of Products.



920-857-9069

Séura, Inc.
1230 Ontario Road
Green Bay, WI 54311
t: 920.857.9069
f: 920.857.9490

© Séura 2017
All Rights Reserved

4/17/17



SÉURA®

www.seura.com